

DERBY

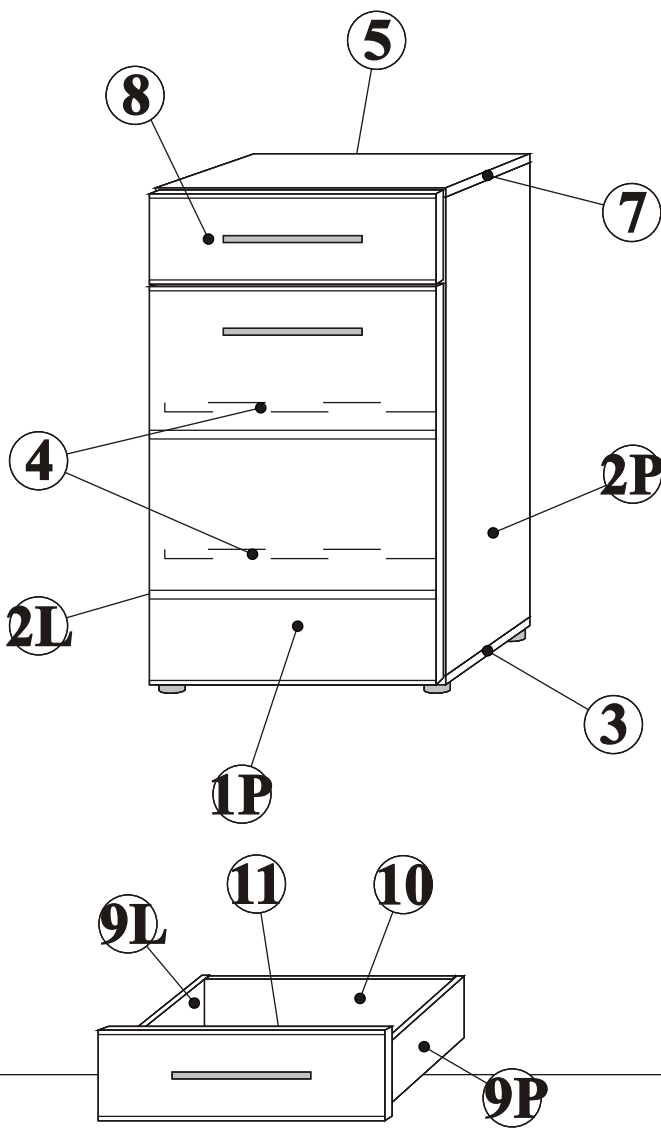

- A1** 2 \square 36 16
- B5** 4
- B4** 4
- G5** 15 4
- B11** \square 50 4
- D27** \times 6 \square 4
- I1** \times 2 4
- D18** \times 4 2
- G7** 4
- G1** 1
- S1** 4
- E1** \times 2
- B3** \times 5
- D10** \times 3 \square 5r13 \times 4
- UL** 224 2
- E2** 50 \square 2
- UP6** \times 4 \square 30 4
- EK2** \times 6 \square 3 4
- D11** \times 3 \square 5 \square 25 \square 4
- G2** 4 1
- I11** \square 4

1

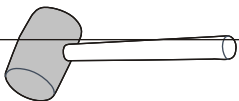
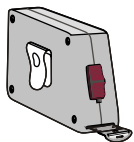
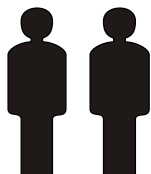
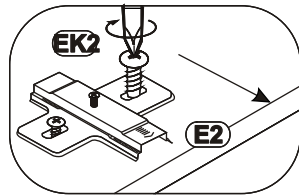
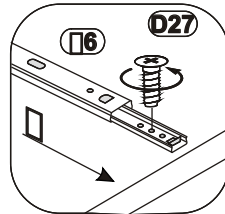
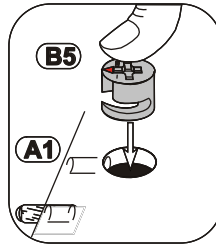
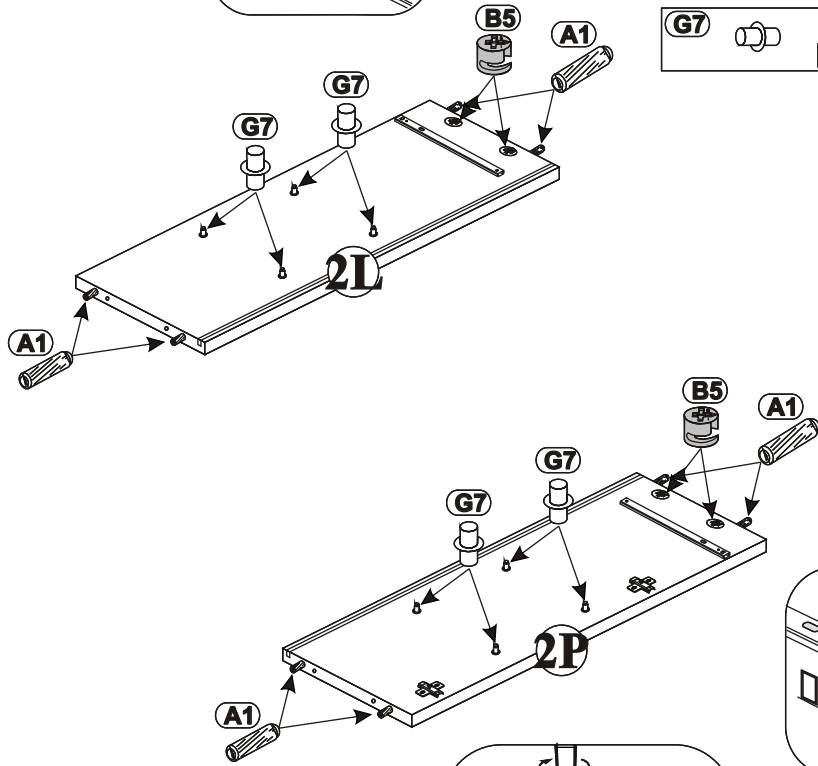
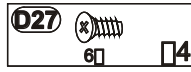
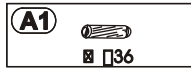
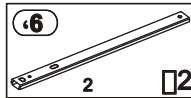
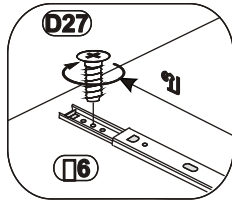

2

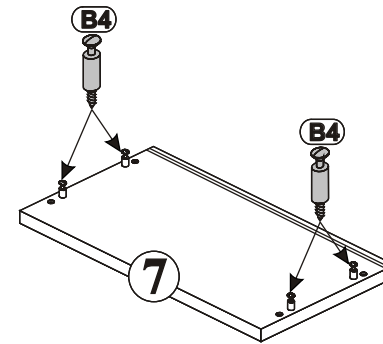
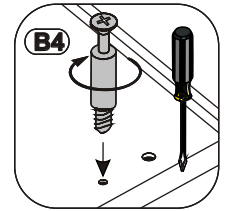
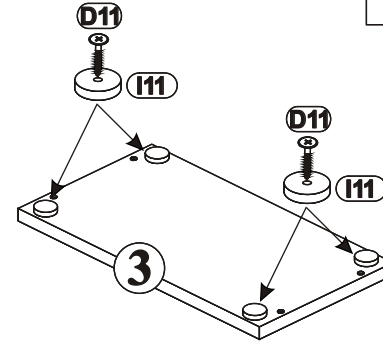
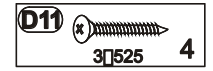

3

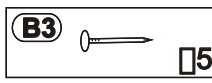
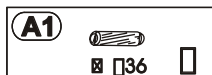
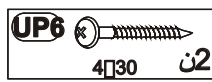
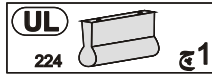
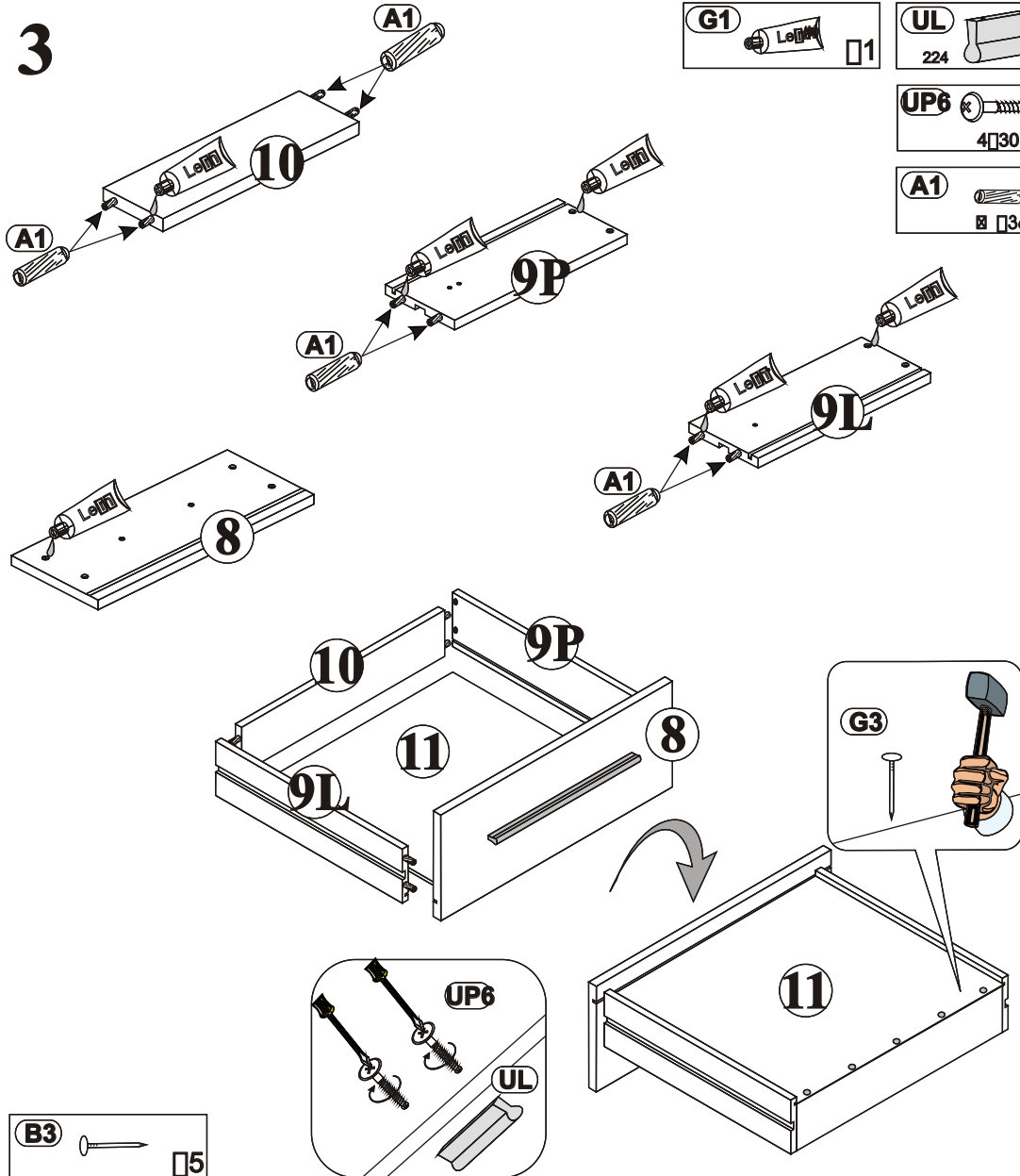

4

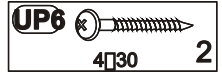
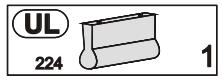
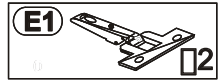
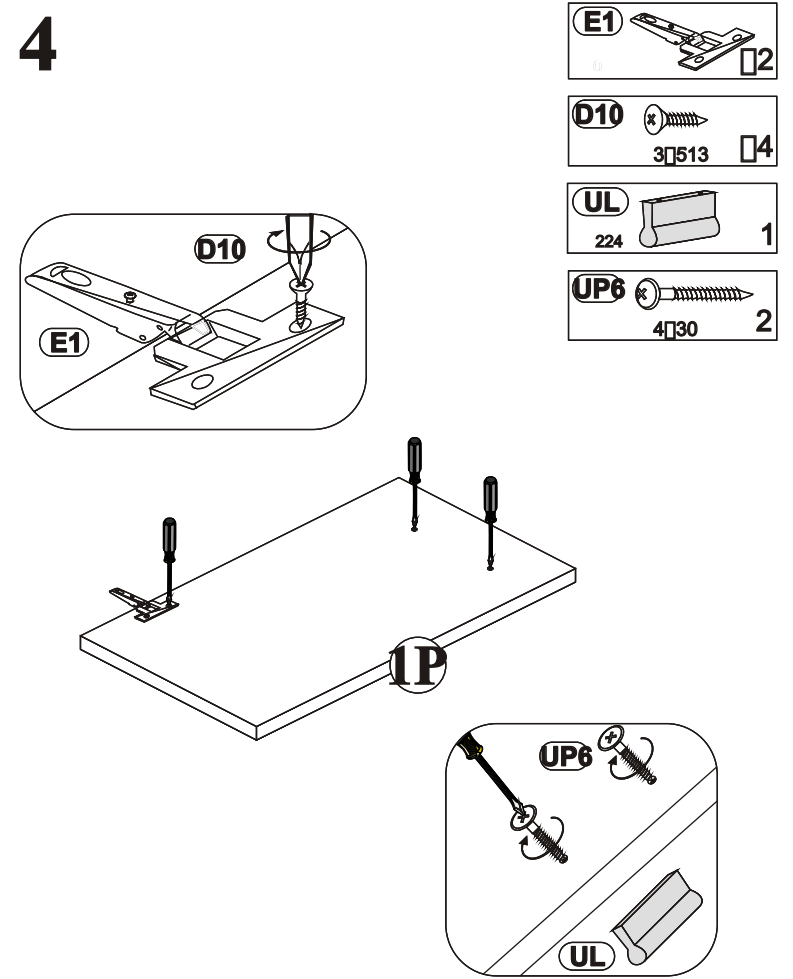

5

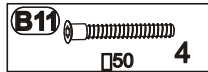
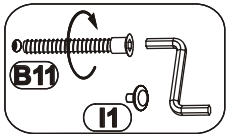
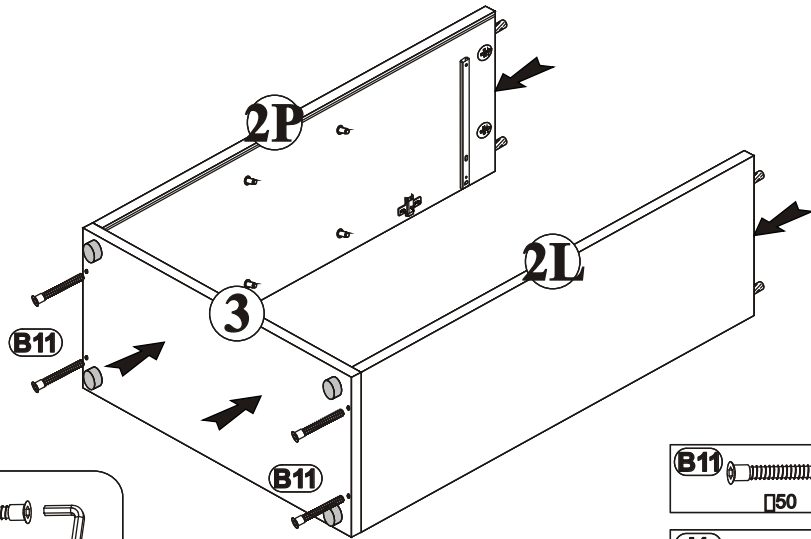

6

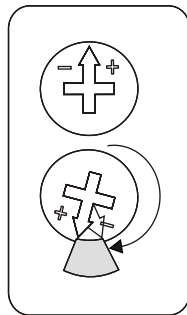
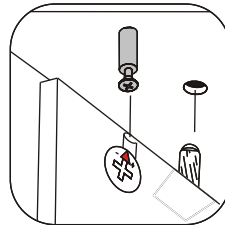
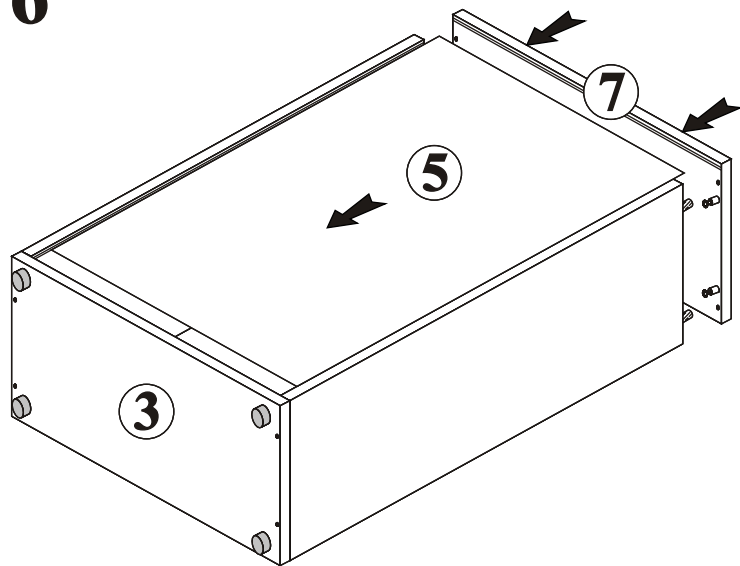

7

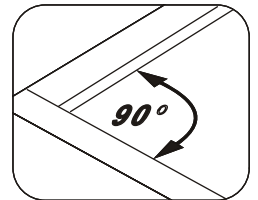
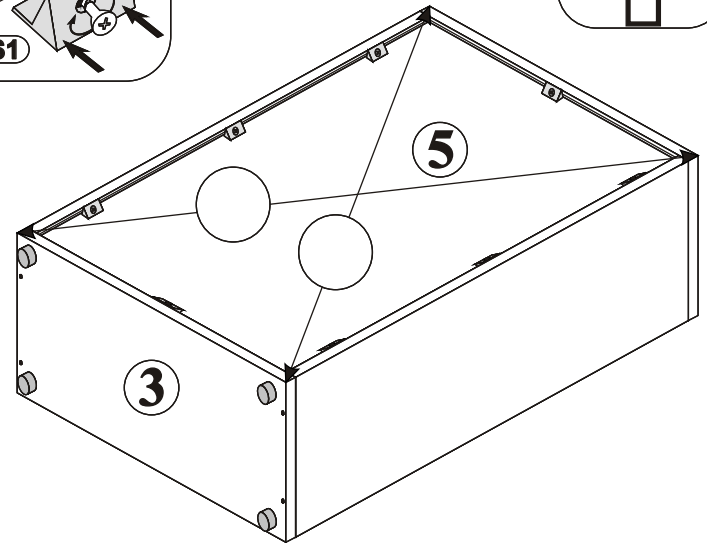
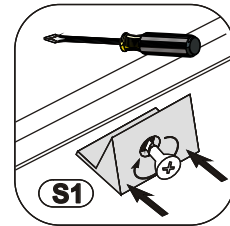

8

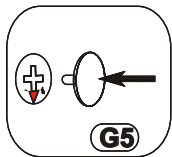
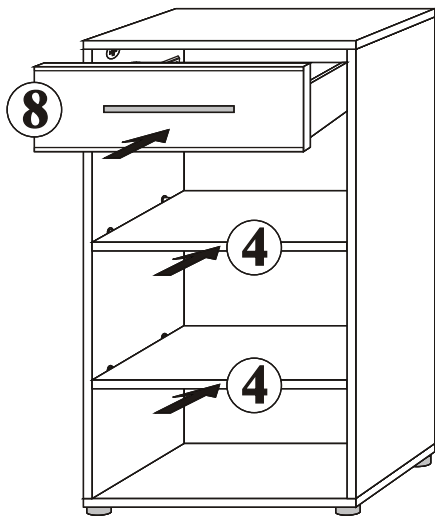

9

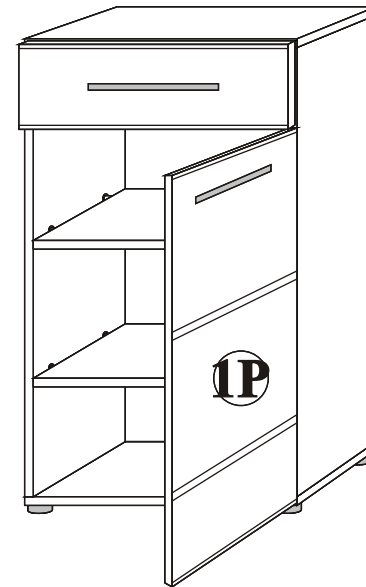
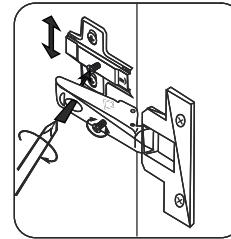

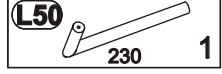
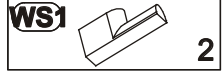
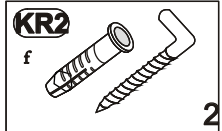
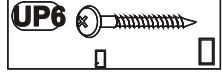
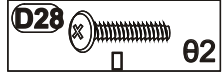
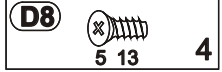
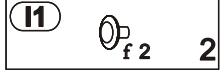
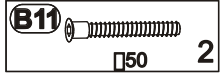
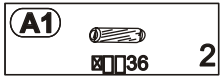
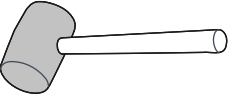
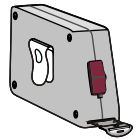
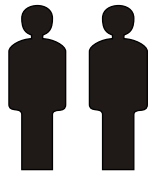
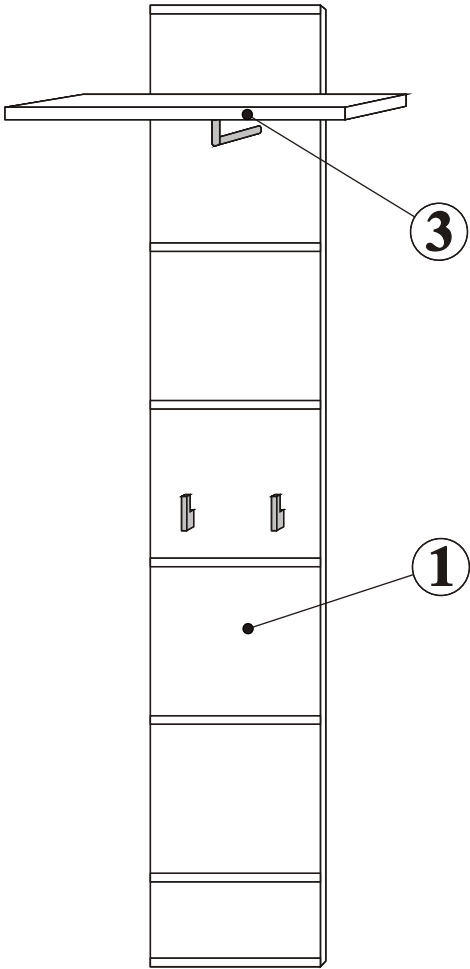

1

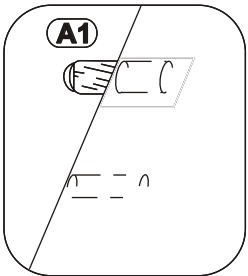
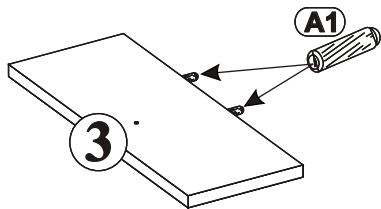
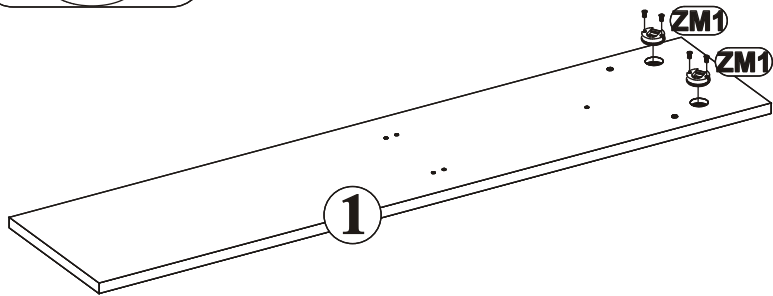
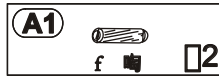
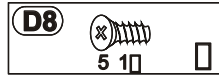
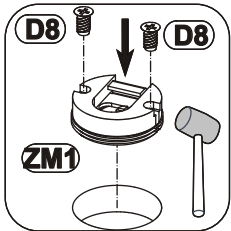

2

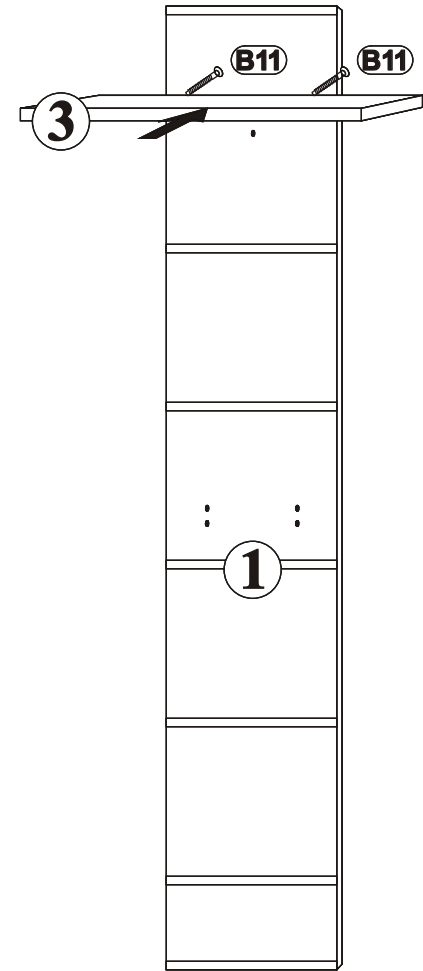
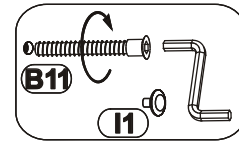
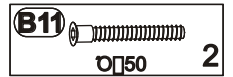
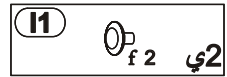

3

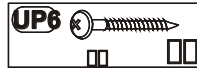
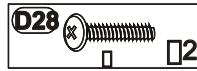
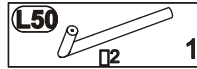
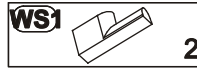
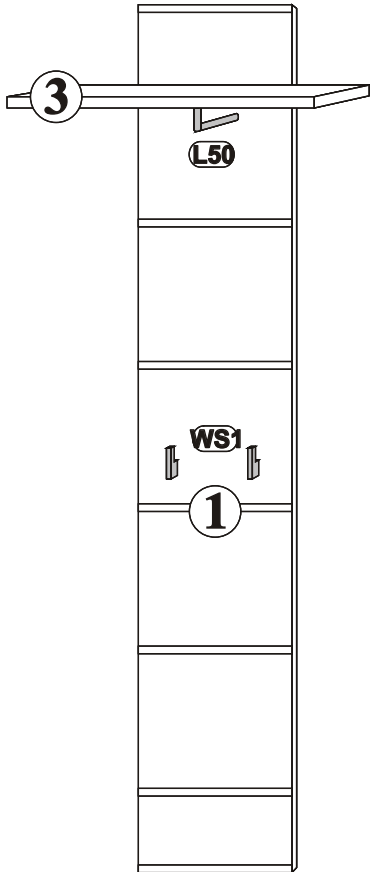
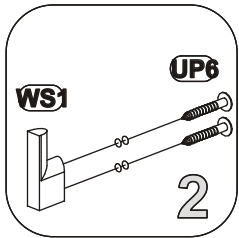
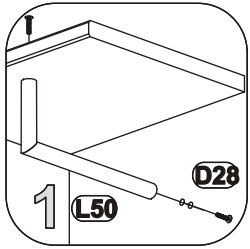

4

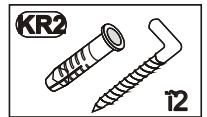
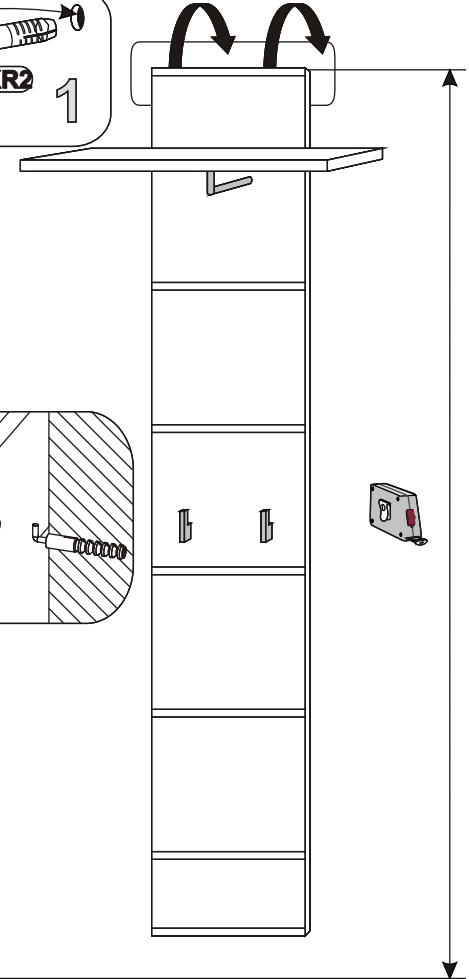
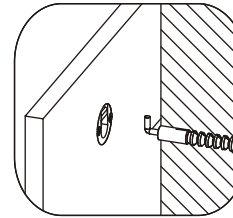
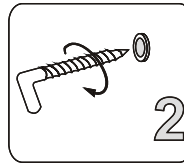
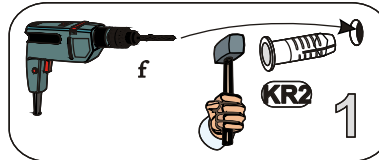

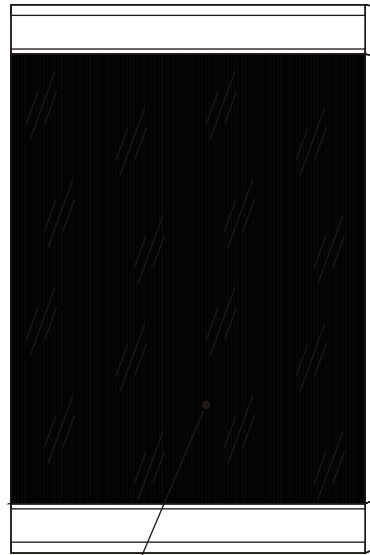
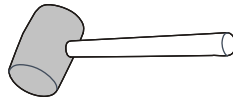
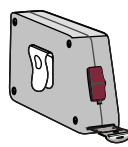
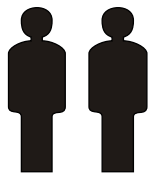

1

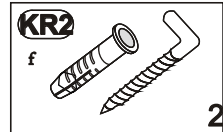
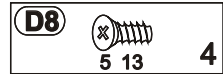
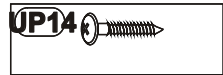
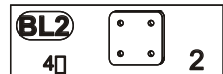

1

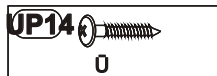
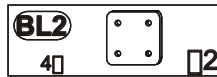
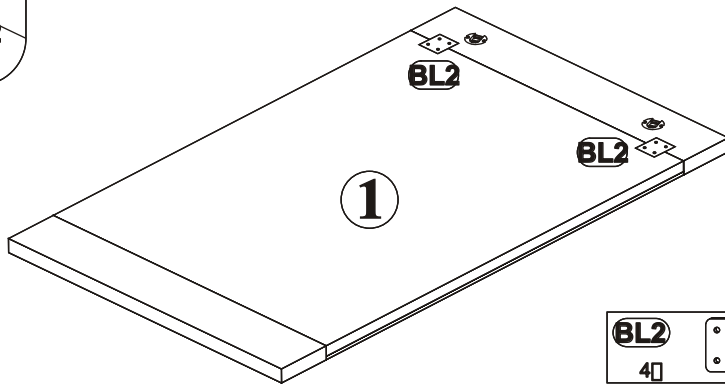
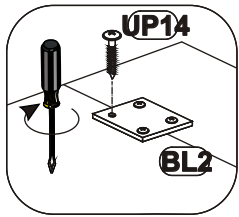
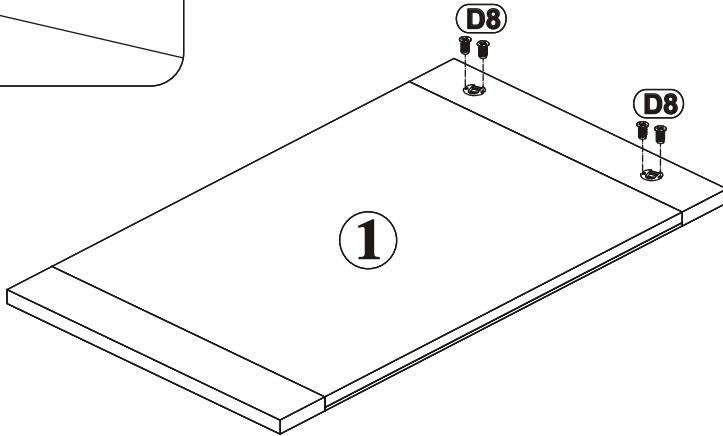
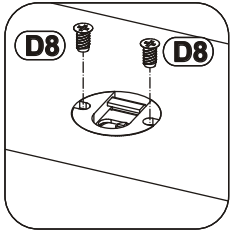

2

